

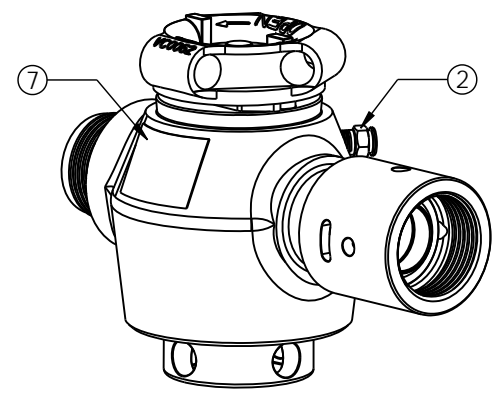









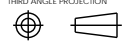

ITEM NO.	QTY.	PART NUMBER	DESCRIPTION
1	1	VC0380	VLV BODY, 2" x WS20TN STD 15M
2	1	HC0226	GREASE FITTING, 3/4" SAFETAP H2S GBH
3	1	UC0115	SEAL, WS20 H2S 15M
4	1	UC0116	NUT RETAINER RING, WS20
5	1	UC0118	NUT MEMBER, WS20 15M
6	1	UC0119	SEAL SHROUD, WS20
7	1	VC0013	NAME TAG-VALVE (MSI/DIXIE)
8	1	VC0024	PLUG, 2" STD
9	1	VC0027	INSERT, 2" STD
10	1	VC0028	ADJUSTING NUT, 2" H2S
11	2	VC0005	PLUG SEAL, 2" H2S (BUNA/BRASS)
12	2	OC0016	O-RING, 2" INSERT H2S
13	1	OC0020	O-RING, 2" ADJ NUT H2S
14	2	HC0006	FLAT WASHER, 1/2" STD
15	2	HC0007	FLAT WASHER, 1/2" OVERSIZED
16	1	HC0008	SOC HD, 1/2"-13 x 0.50"
17	2	HC0009	HEX HD, 1/2"-20 x 1.00"
18	1	VC0061	STOP COLLAR, 2", 3", 4"
19	1	VC0062	HANDLE ADAPTER, 2", 3", 4"



<p>THIS DRAWING IS THE PROPERTY OF DIXIE IRON WORKS, LTD. THE BORROWER AGREES BY RECEIVING THE DRAWING TO RETURN IT UPON REQUEST AND TO NEITHER REPRODUCE COPY OR FURNISH INFORMATION FROM IT TO OTHERS WITHOUT EXPRESSED WRITTEN PERMISSION OF DIXIE IRON WORKS, LTD. ALL ARTICLES MANUFACTURED IN ACCORDANCE WITH THIS DRAWING SHALL BE CONSIDERED DESIGNS OF DIXIE IRON WORKS, LTD. AND MAY NOT BE USED OR SOLD WITHOUT DIXIE IRON WORKS, LTD. WRITTEN PERMISSION.</p>	<p>NOTES</p> <ol style="list-style-type: none"> <li>BREAK ALL EDGES 0.008/0.016 x 45° OR R0.008/0.016 EXCEPT THREADS.</li> <li>ALL MACHINED CORNER RADII TO BE R0.031.</li> <li>ALL DIMENSIONS ARE IN INCHES (UNLESS OTHERWISE STATED).</li> <li>BLUNT START ALL TAPED THREADS.</li> <li>ALL DIAMETERS TO BE CONCENTRIC WITHIN 0.005 (UNLESS OTHERWISE STATED).</li> <li>MACHINED SURFACES TO BE 125µm Ra UNLESS OTHERWISE STATED.</li> <li>ALL DIMENSIONS IN PARENTHESIS ARE REFERENCE DIMENSIONS (X.XXX).</li> </ol>	<p>UNSPECIFIED TOLERANCES</p> <p>FRACTIONS ±1/64 DECIMALS .XX ±0.010 XXX ±0.005 XXXX ±0.001</p> <p>ANGLE ±1/2°</p>	<p>REVISION</p> <p>0</p>	<p>CHANGE MADE</p>	<p>ECN NUMBER</p>	<p>DESCRIPTION</p> <p>VALVE, 2" x WS20TN STD 15M (HI-TEMP)</p>	<p>COMPUTER GENERATED BY</p>  <p>300 West Main Street Alice, Texas 78532</p>		
	<p>THIRD ANGLE PROJECTION</p> 	<p>DATUM INDICATING SYMBOL</p> 	<p>CONCENTRICITY</p> 	<p>ANGULARITY</p> 	<p>RUNOUT</p> 	<p>COUNTERBORE</p> 	<p>MATERIAL/HEAT TREAT/WELD PROCEDURE</p> <p>STANDARD SERVICE 15,000 PSI WORKING PRESSURE</p>	<p>DRAWN BY</p> <p>WJT</p>	
	<p>POSITION</p> 	<p>FLATNESS</p> 	<p>PERPENDICULARITY</p> 	<p>PARALLELISM</p> 	<p>COUNTERSINK</p> 	<p>WEIGHT</p> <p>82.57 LBS</p>	<p>SHEET</p> <p>SHEET 1 OF 1</p>	<p>DATE</p> <p>07/22/03</p>	<p>PART NUMBER</p> <p>VA0381</p>